

SEGA



Universal Kit

Kit Installation Instructions
& Service Manual

Switchable *FROM* High Resolution 31K
TO Standard (Low) Resolution 15.75K.

2 - 4 PLAYER GAME

Kit come with two (2) JVS/JAMMA Interface
Boards for **four (4) Player Action.**

Warranty

Your new Sega Product is covered for a period of 90 days from the date of shipment. This certifies that the Printed Circuit Boards, Power Supplies and Monitor are to be free of defects in workmanship or materials under normal operating conditions. This also certifies that all Interactive Control Assemblies are to be free from defects in workmanship and materials under normal operating conditions. No other product in this machine is hereby covered.

Sellers sole liability in the event a warranted part described above fails shall be, at its option, to replace or repair the defective part during the warranty period. For Warranty claims, contact your Sega Distributor.

Should the Seller determine, by inspection that the product was caused by Accident, Misuse, Neglect, Alteration, Improper Repair, Installation or Testing, the warranty offered will be null and void.

Under no circumstances is the Seller responsible for any loss of profits, loss of use, or other damages.

This shall be the exclusive written Warranty of the original purchaser expressed in lieu of all other warranties expressed or implied. Under no circumstance shall it extend beyond the period of time listed above.

FIG. 1

Kit Overview

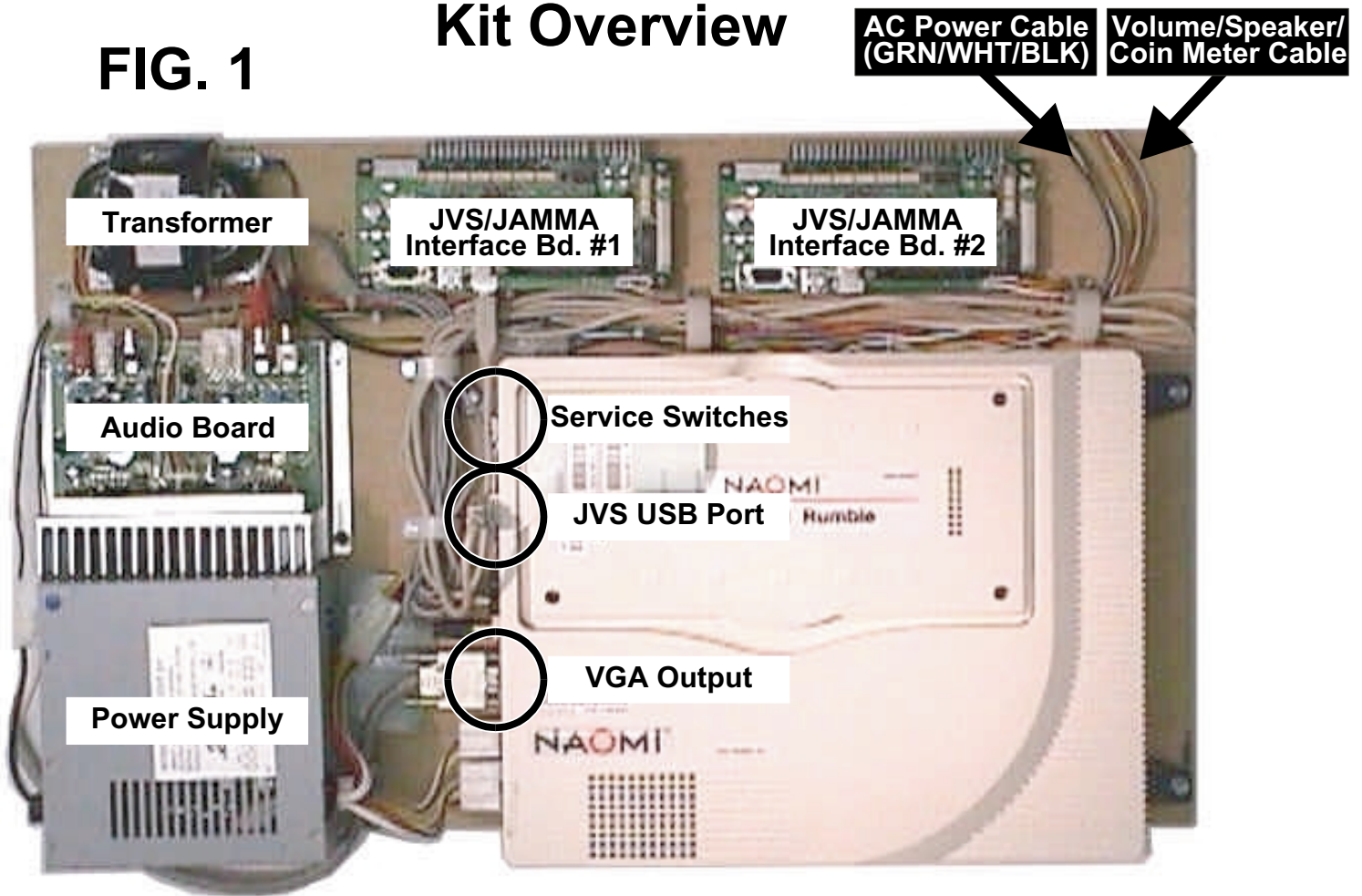

Template Layout

***** See Pages v & vii to copy & cut templates

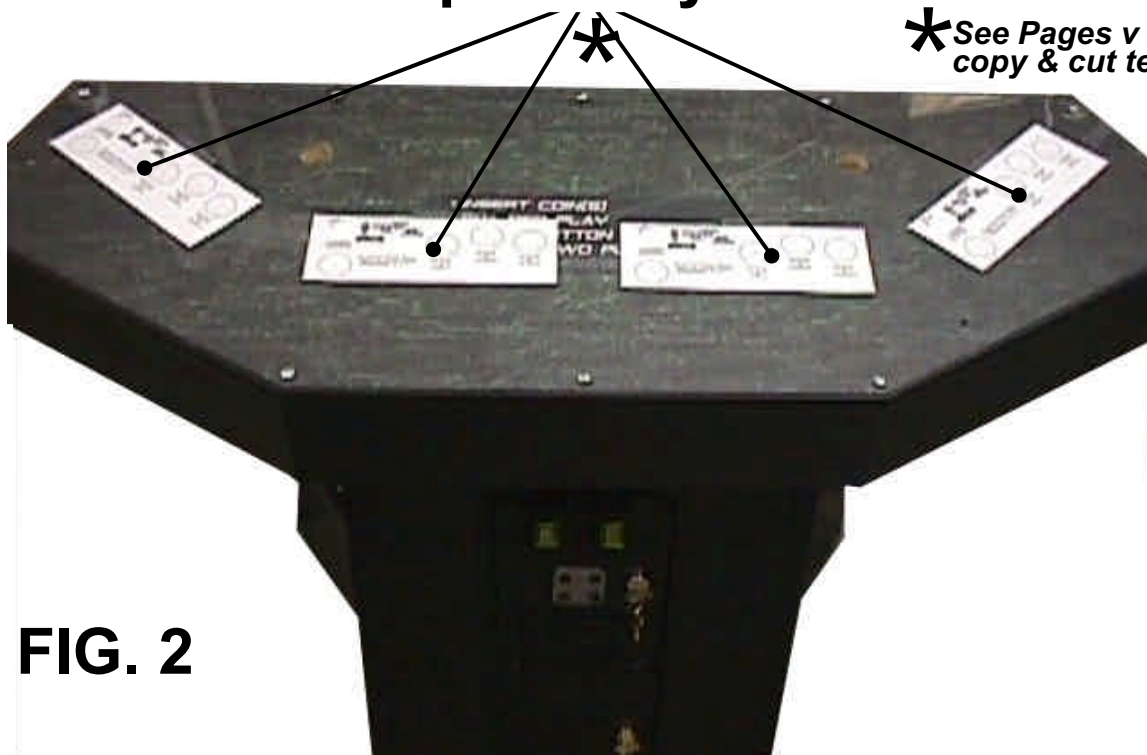

FIG. 2

WWF Royal Rumble Sega Naomi System Kit Contains List

Part #	Desc	Qty
840-0040D-01	WWF GAME BD ASSY	1
838-13616	AUDIO AMP (NAOMI)	1
560-5407-UL	TRANSFORMER	1
838-13683-93CV1	JAMMA I/O BD (NAOMI)	2
400-5397	POWER SUPPLY (NAOMI)	1
600-7141-200	USB CABLE	1
600-7009-2500	VGA VIDEO CABLE	1
999-1137	MARQUEE	1
999-1140	INSTR SHEET (CTRL DESC)	1
999-1141	INSTR SHEET (PLAYERS)	1
999-1138	CTRL PANEL OVERLAY	1
999-1142	SIDE DECALS	2
999-1139	BUTTON SHEET	1
XXXXXXXXXX	8 WAY JOYSTICK	4
XXXXXXXXXX	PUSHBUTTONS FOR CTRLS	12
XXXXXXXXXX	SERVICE SWITCH BRKT ASSY	1



SERVICE BULLETIN

SEGA Service Department
45133 Industrial Drive
Fremont, Ca. 94538

Feb 9, 2000
<http://www.seuservice.com>
Phone: 415.701.6580
Fax: 415.701.6594

120

SPECIAL NOTICE FOR ALL SEGA NAOMI KITS

PROBLEM:

The SEGA Naomi Game kits are actually 'JAMMA Dependent'. What this means exactly is they will only install into existing JAMMA Cabinets. If an operator tries to install these kits into a Non-JAMMA cabinet, they will first have to bring the wiring up to JAMMA Standards.

SOLUTION:

- Step 1 Disconnect the games original DC Power Supply. You may only use the power supply provided with your kit. Be sure to set the voltages going to your Game BD to 5.1 and 3.3 volts DC to assure proper operation (Measure on Square Connector at Game BD. Yellow = 5vdc / Brown = 3.3vdc / White = Gnd)
- Step 2 You MUST USE THE COIN METER SUPPLIED WITH YOUR KIT to assure proper Coin acceptance. A minimum 18 Gauge wire should be used from the Coin Meter 1 output line on your JAMMA Harness. The 5vdc (Yellow) wire found in the wiring bag of your kit MUST BE USED for the supply voltage to the meter.



IMPORTANT!

Not following the directions provided herein may cause your game to malfunction. All electrical work should be performed by the site's Serviceman or Technician.



WARNING!

- In order to prevent an electric shock and short circuit, be sure to turn power off before performing work or touching the interior parts of the product.
- Be careful so as not to damage wirings. Damaged wiring can cause an electric shock or short circuit accident.
- Do not touch places other than those specified. Touching places not specified can cause an electric shock or short circuit accident.

If you have any questions please contact the SEGA Service Department at the numbers given above.

INSTALLATION INSTRUCTIONS

- 1) First. Remove all access panels from the game. Locate the original game Logic PCB's & Power Supply and remove from the Cabinet by first disconnecting all harnesses from the boards. (You need only to splice in the Main Power (110v AC) into the 3-Pin Connector (GRN/WHT/BLK).)
- 2) Remove all existing game harnesses (we suggest using New Jamma Harnesses (*NOT contained in the kit*) to ensure reliability).
- 3) Locate the most convenient and open area of the cabinet to mount the WWF Naomi System Assembly. Make sure this area is free and clear of all cable harnesses and grounds, cable clamps, etc. (See FIG. 1, inside cover).

Vacuum out or clean bottom of cabinet of dirt & miscellaneous parts (e.g. screws, loose coins / tokens, etc.).

 Good Idea!

 Good Idea!

Remove all exterior decals and repair any cabinet damage. Repaint cabinet if necessary. Remove the Monitor Plexi or if your game plexi has Silk-screened artwork, you will need to strip it off.

- 4) Connect the JAMMA Harnesses to the JVS-JAMMA Interface Boards. Separate the wires from each other (i.e. Control Panel, Video, Speaker, Power Supply). Run the various harnesses to the part of the cabinet they go to ensuring they are dressed properly & secured to the cabinet. (See FIG. 4 Pg. iv). Locate the Volume/Speaker/Coin Meter Cable and connect to your existing **Diag. Switch Bracket** or use the new one included with the kit. (See FIG. 3, Pg. iii). **Note:** *If you are using a VGA Compatible Monitor you can run your VGA Cable directly to the monitor or connect it to your JVS JAMMA Interface for RGB Conversion to your JAMMA Cables.*
- 5) Remove Marquee from cabinet and cut to fit the new WWF Marquee in place.

WWF uses 1 Lever (Joystick) with 3 Multi-Function Switches (Buttons) for controls and a Start Button per player. **REPLACE** old Joysticks & Buttons with the **NEW** ones supplied in Kit.

 Good Idea!

- 6) First remove all Joystick and Button assemblies from the Control Panel. Remove Lexan and Control Panel Overlay. Proceed to clean surface of the Control Panel by removing all adhesive and dirt. Fill in or plug up existing button holes to set up a blank work area for your (1 - 4) templates (See Pages v & vii, COPY & CUT).
- 7) Carefully tape template on the Control Panel in configuration of 2 - 4 player; using a Center Punch, mark your hole centers. With a 1 1/8" Hole - Saw, proceed to drill out holes for the new Control Panel configuration. Once drilling is complete, clean surface once again eliminating all wood chips and dust. (See FIG. 2, inside cover).
- 8) Install the new Control Panel Overlay by carefully peeling off the paper backing and laying down on the panel. Smooth it out, starting in the center and working your way to the edges (removing all of the trapped air pockets). If necessary, cut the edges of the overlay excess and fold under panel.
- 9) Cut out the button and Joystick Holes. Install Joystick and buttons from kit into the Control Panel and tighten down. Connect all game harness wires to switches and buttons.

INSTALLATION INSTRUCTIONS

10) Proceed to place new decals on the sides of the cabinet. Locate a new monitor bezel, if needed, and replace glass, if required (due scratches). Install Instruction Placard to the back of the Monitor Glass.

NOTE: As a precaution, disconnect the JAMMA Harness from the I/O Boards and turn power on. With a Multi-Meter, measure the 5v and adjust if necessary to 5.15v DC. Measure the +12, -12 and -5 to ensure the wires and voltages are in the correct position. Turn power off. Plug in the JAMMA Harness once again to the I/O Boards. The Attract Mode should appear on the screen.

Adjust the **SIZE, CONTRAST, BRIGHTNESS, and COLORS** on the Monitor for optimum appearance. Adjust **VERTICAL/HORIZONTAL Hold** to get a stable picture, if required.



Enter **DIAGNOSTICS** and adjust the Volume Level, test all Buttons & Joystick for proper operation & wiring. Adjust Pricing. Coin-Up and test out a game to ensure proper play functions are as they should be.

Sega Naomi System Switch Bracket and Speaker Installation Diagrams (Figure 3)

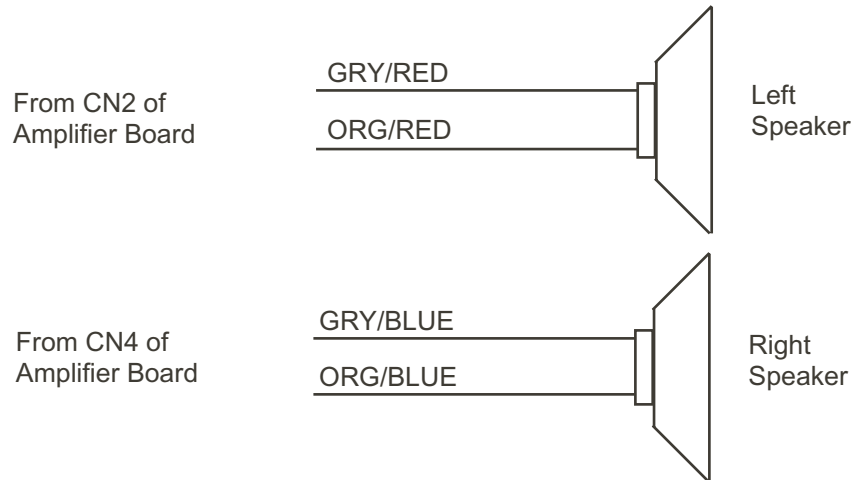
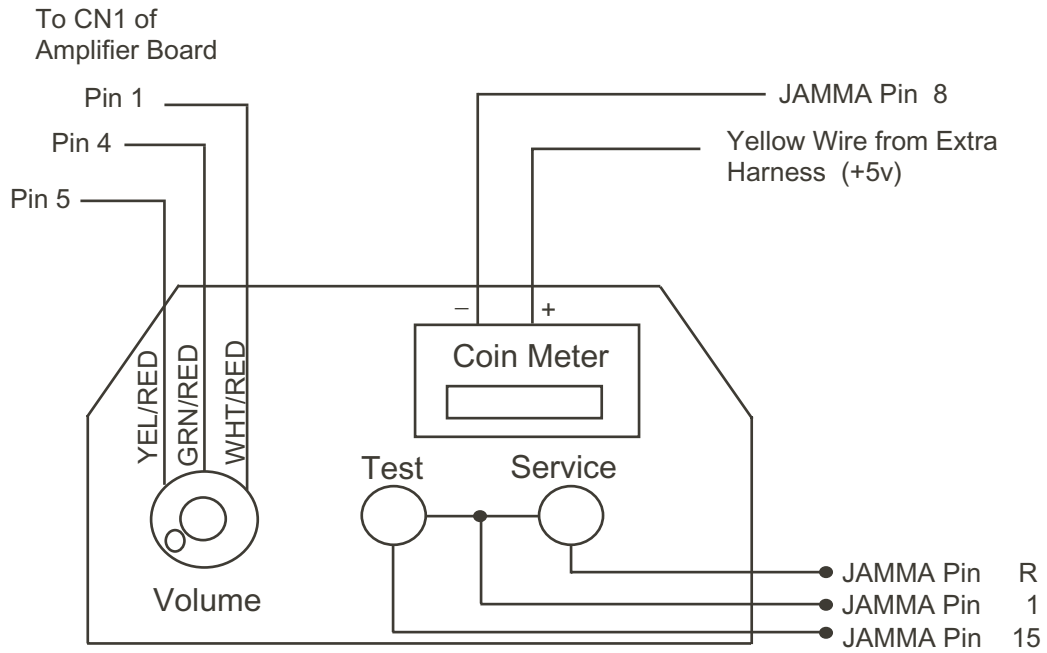

Sega Naomi System

JAMMA Harness Wiring

(JAMMA I/O BD)

(Figure 4)

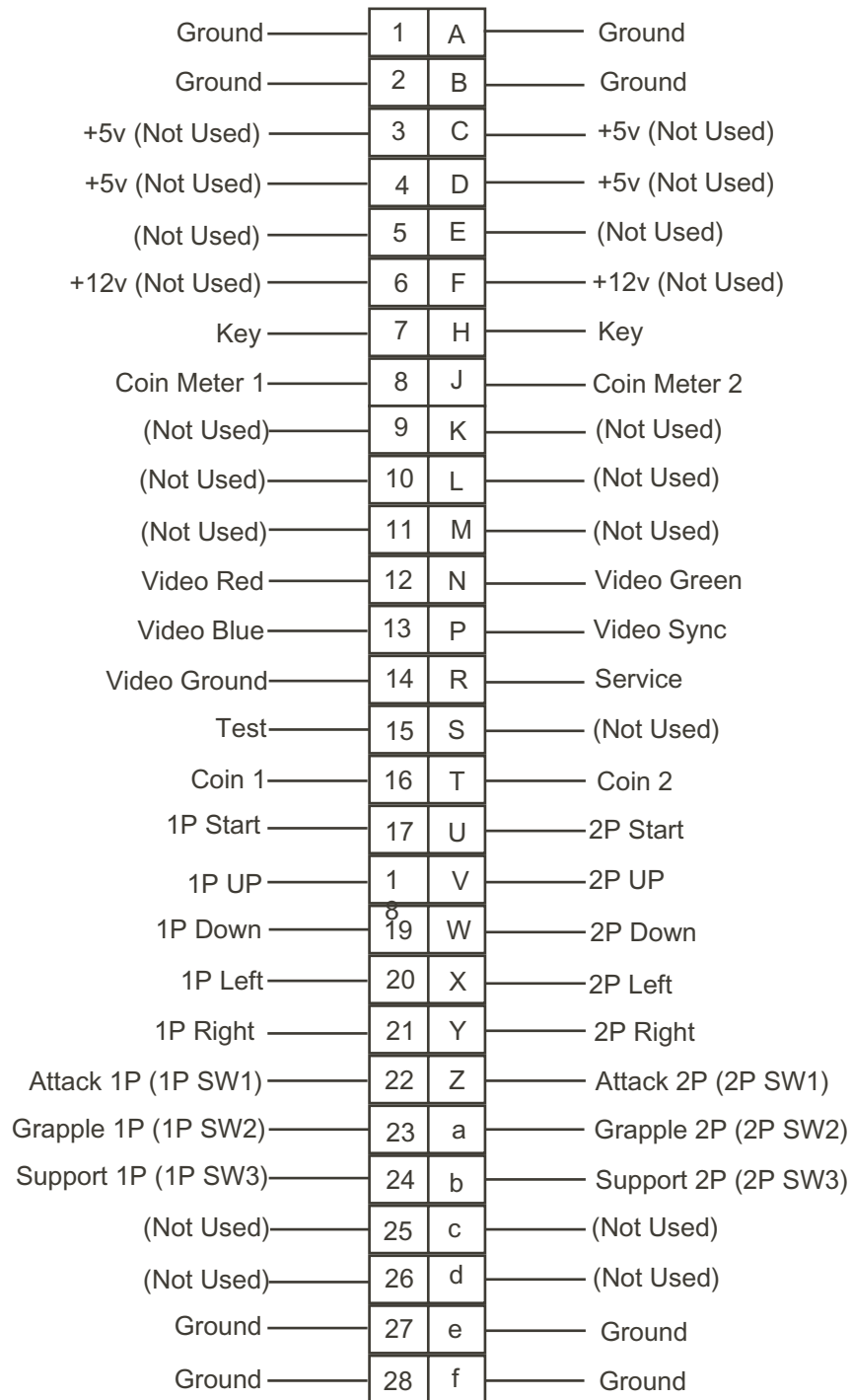

Sega Naomi System Filter Board Information Connector Description etc.

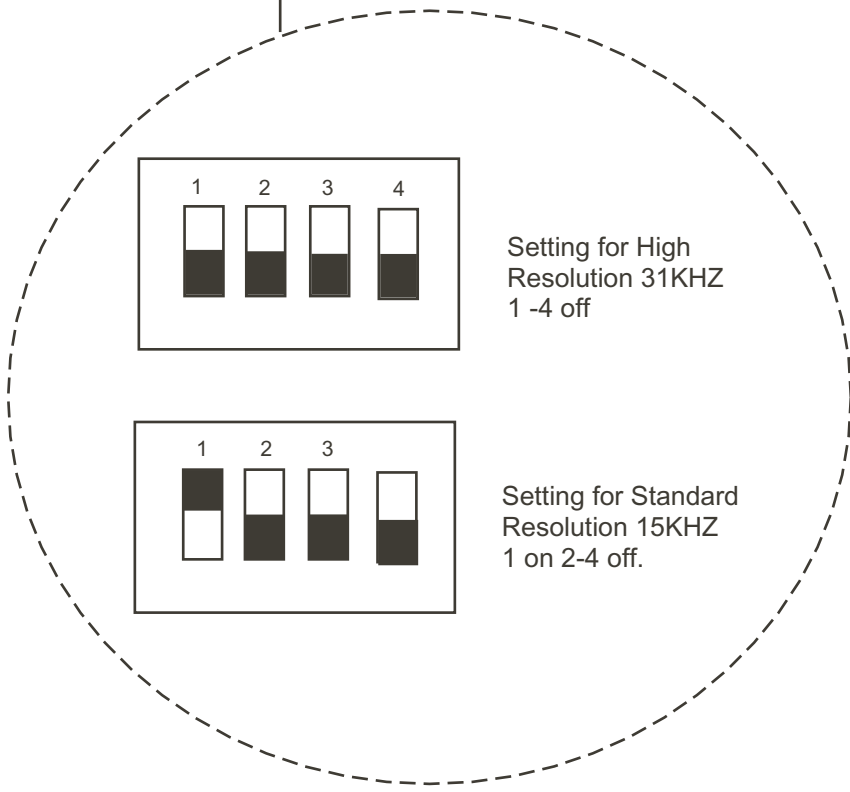
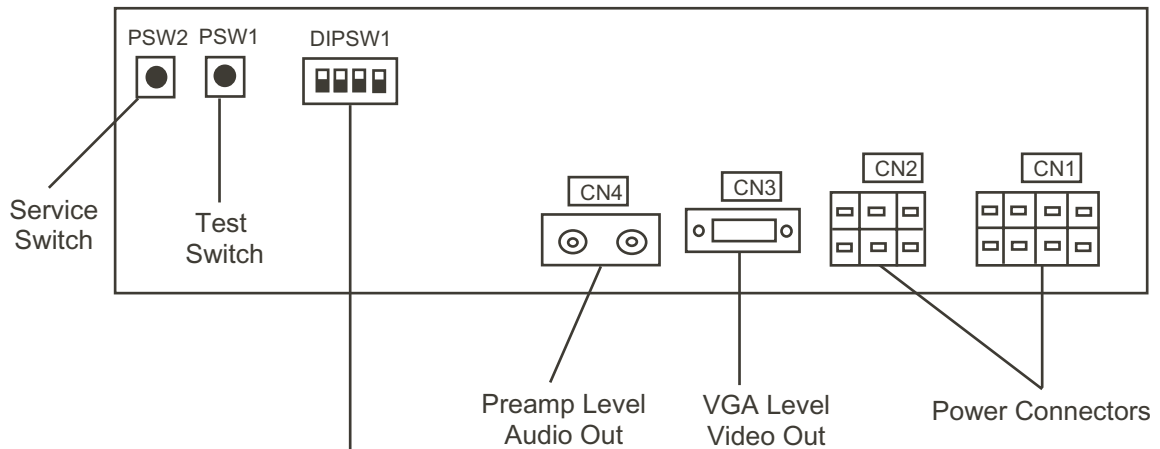



BUTTON LAYOUT CONFIGURATION

Below are *Actual Size Templates* for
PROPER ERGONOMIC PLACEMENT
 of your *Control Panel Buttons*.
 (Copy this page to cut templates at dotted lines.)

Cut Copied Page Only



LEVER
(JOYSTICK)

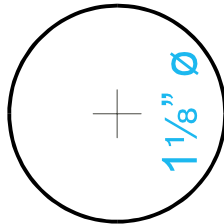

**Typical Hole Saw
 Diameter = 1 1/8"**

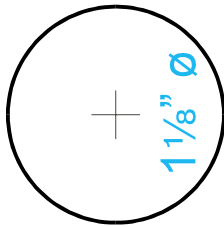

**BUTTON
 "A"
 (Attack)**

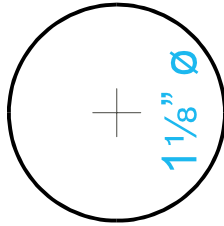

**BUTTON
 "G"
 (Grapple)**

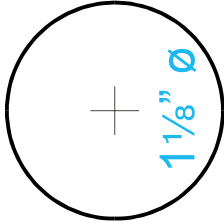

**BUTTON
 "S"
 (Support)**



LEVER
(JOYSTICK)

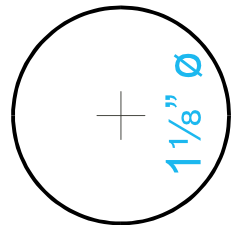

**Typical Hole Saw
 Diameter = 1 1/8"**

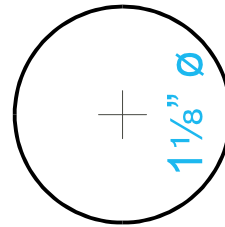

**BUTTON
 "A"
 (Attack)**

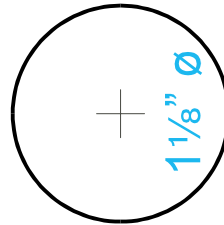

**BUTTON
 "G"
 (Grapple)**

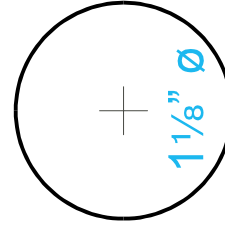

**BUTTON
 "S"
 (Support)**

THIS PAGE INTENTIONALLY BLANK



BUTTON LAYOUT CONFIGURATION

Below are *Actual Size Templates* for **PROPER ERGONOMIC PLACEMENT** of your *Control Panel Buttons*.
(Copy this page to cut templates at dotted lines.)

Cut Copied Page Only



LEVER
(JOYSTICK)

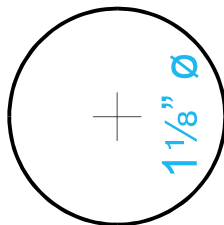

Typical Hole Saw
Diameter = 1 1/8"

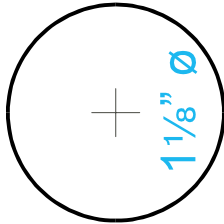

BUTTON
"A"
(Attack)

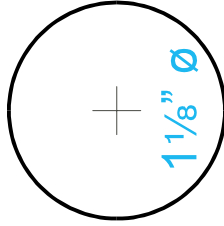

BUTTON
"G"
(Grapple)

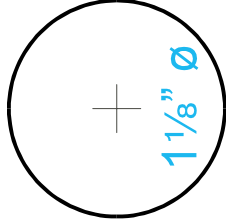

BUTTON
"S"
(Support)



LEVER
(JOYSTICK)

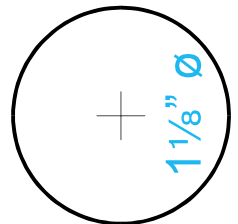

Typical Hole Saw
Diameter = 1 1/8"

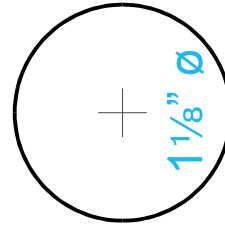

BUTTON
"A"
(Attack)

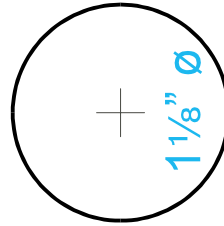

BUTTON
"G"
(Grapple)

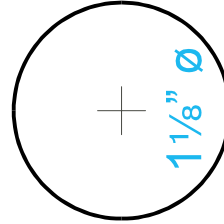

BUTTON
"S"
(Support)

THIS PAGE INTENTIONALLY BLANK

2. HOW TO PLAY

ON-SCREEN DISPLAY

Monitor Position



Synchronous Frequency
15/31 kHz

CONTROL PANEL

Moving of Wrestlers

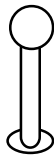

Attack Button



Grapple Button



Support Button



Attack Button	Enables a wrestler to punch and kick an opponent.
Grapple Button	Enables a wrestler to grapple an opponent. Also enables a wrestler to throw, or swing onto the ropes, an opponent after grappling.
Support Button	Enables a wrestler to take an action other than attacking and grappling; that is, to run, mount to a corner, guard, and block.

Available Playing Modes

Two playing modes are available.

Exhibition Mode

This enables you to play a 10-game tournament. You choose a wrestler as yourself and a partner wrestler, and specify the attacks allowed for the partner; thus you may use your own vital techniques as well as the various partner attacks in the game. Additional wrestler (from the CPU) may unexpectedly burst into the ring or you may happen to move to a variety of stages; thus several game effects are prepared.

Maximum 4 wrestlers can play simultaneously. In this case all the wrestlers other than yourself (as a wrestler) may be opponents; you may attack one of them together with the rest of them; or any one of the supporting wrestlers may suddenly betray you. Thus you can enjoy a heated and thrilling game.

Royal Ramble Mode

This enables you to join in a battle royal of maximum 9 persons on the ring. Maximum 4 wrestlers can play. Any wrestlers fallen from the ring is disqualified. The bottom center part of the monitor screen shows the number of persons to clear; new wrestlers will continue to appear on the ring until the number becomes 0 (zero). The number counts down only if the playing wrestlers make the CPU wrestler fallen from the ring. Winning wrestlers are those who still remain on the ring when the number is 0 (zero). Furthermore, the high-level S wrestlers may burst into the ring when the number of persons to clear approaches to 0 (zero).

Attack Button

This button enables you to punch and kick an opponent. Press the button repeatedly to attack without a break.

Grapple Button

This button enables you to grapple an opponent and then make him staggered or groggy, throw him or swing him onto the ropes. The button also enables you to throw down or squeeze a downed opponent. Furthermore, the button enables you to pick up a weapon on the stage other than the ring.

Support Button

This button enables you to run into the directions set by the lever; and then you may use the attack and/or grapple buttons to battle. If you are nearby the corner, you may set the lever into the direction of the post, press the button to mount to the corner, and use the attack and/or grapple button to battle. Also, you may hold down the button to guard yourself against an opponent's offences. In addition, you may press the button in a timely manner against an opponent's offence thereby to counterattack. Finally the button enables you to pinfall a downed opponent.

◆ **Button Operations after Grappling**

Pressing the Attack Button after Grappling

This action enables you to make an opponent groggy (defenseless). This action, if taken while setting the lever into any desired direction, enables you to make an opponent staggered (also, defenseless) into the set direction. Press the attack button again to punch or kick the groggy or staggered opponent while the grapple button to throw. In these cases, the opponent cannot counterattack.

Pressing the Grapple Button after Grappling

This action, if taken while setting the lever into any of the neutral/upper/lower/left/right directions, enables you to throw a grappled opponent even if grappled in the rear.

Pressing the Support Button after Grappling

This action enables you to swing or hammer-throw an opponent onto the ropes. After swinging, press the attack or grapple button to battle. Alternately set the lever into any desired directions to swing the opponent into the set direction. Set it into a slant direction to swing the opponent to the corner in the set direction and thus make the opponent corner-down. Grapple, and then punch, kick, or throw the corner-downed opponent.

NOTE: When grappled you can counterattack by pressing the button same as the one opponent is pressing.

■ **Partner Attacks (in Exhibition Mode)**

According to a WWF rule, you specify your own wrestler and its partner. Attacks by the partner are called partner attacks. You also specify any one out of the three partner attacks; Type A, Type B, and Type C. You can use a partner attack by pressing any two buttons simultaneously.

Independent Partner Attacks

Only a partner wrestler attacks an opponent. These attacks include a dashing punch/kick, continuous attack, weapon attack, dived attack from a corner, and vital technique.

Two-Platoon Attacks

You (as a wrestler) may try to grapple (or punch or kick) an opponent. After successfully grappling, you and the partner cooperate to do the two-platoon attacks.

Supporting Partner Attacks

The partner does not attack but provides various supporting actions. Such actions include giving of a weapon, increasing of your special gauge number, decreasing of an opponent's special gauge number, making an opponent groggy, escaping from a pitfall, etc.

NOTE: The Partner Attack are not usable in a wire-netting stage.

■ **“S” Special Gauge Icon**

Special gauge icon is located below a power gauge icon and indicates a “S” number. Saving and increasing of the “S” number enables you to use high-grade (HG) attacks, vital techniques, etc. You can use these features by pressing the three buttons simultaneously.

HG Attacks (decreasing of “S” number: 1 each)

HG attack is more powerful than a usual one. Such powerful attacks include a dashing attack, attack from a corner, downward attack, etc. and thus are usable in various situations.

Vital Technique (decreasing of “S” number: 3 each)

Every wrestler is given one vital technique (and two lock techniques). Applicable situation of these techniques varies from wrestler to wrestler. One technique is only applicable in a standing position, another for a downed opponent, and the other from a corner. Each vital technique can seriously damage an opponent and even KO a powerless opponent.

Escaping from a Pinch (decreasing of “S” number: 1 each)

You can escape from a pinch such as a pinfall, groggy state, downed state, grappled state, etc.

■ **Special Operations with Royal Ramble Mode**

The royal ramble mode has a rule of making an opponent fallen from the ring. This needs to specify special operations that an exhibition mode does not support.

How to make an opponent fallen from the ring

◆ **To grapple an opponent nearby the ropes and hammer-throw him into outside the ring:**

Grapple an opponent nearby the ropes, set the lever into outside the ring, and press the support button.

NOTE: In an exhibition mode this is to hammer-throw into inside the ring.

◆ **To make an opponent stagger into outside the ring:**

Grapple an opponent nearby the ropes, set the lever into outside the ring, and press the attack button.

NOTE: In an exhibition mode this is to make an opponent bound against the ropes and stagger.

◆ **To punch or kick an opponent leaning against the ropes:**

If attacked nearby the ropes, an opponent may lean against them and be in a downed state. Punch or kick such an opponent and then you can make him fallen from the ring.

◆ **To raise up and stagger a downed opponent:**

Press the grapple button for a downed opponent to raise up and stagger. You can stagger him into any desired directions; if you set the lever into the direction outside the ring, therefore, you can make him fallen from the ring.

◇ **NOTE:**

An opponent having the power may grasp the ropes and thus resist against falling. If this is the case, press the attack button to stomp the opponent. Grasping the ropes to resist against falling for a prolonged time and losing the power will result in falling from the ring. Get back to the ring by operating the lever. Also, you can return to the ring immediately when pressing the three buttons simultaneously with decreasing "S" number by 1.

■ **Referee Knockout**

You can attack a referee only with a weapon. State of the Referee Knocked Out occurs when you have knocked out the referee twice. In this state the partner attacks can be repeated without a break while usually they can be repeated only with a break. Also in this state you are not counted down even in a pinfall.

■ **Win and Loss Rule (in Exhibition Mode)**

Pinfall

Press the support button for a downed opponent, which starts counting for a pinfall. Alternately, throw down an opponent and press the support button, which also starts counting for a pinfall. In either case you will be a winner if the opponent is counted out to 3. The pinned wrestler may cancel a pinfall by operating the lever. (Turn the lever for an easier cancellation.) Also, you can quickly cancel a pinfall by pressing the three buttons simultaneously with decreasing "S" number by 1.

KO

Exercise a vital technique for a low-power opponent to reduce its power to zero. Then you will be a winner.

Judgment

When the game is ended in a tie, a winner is decided by judging the remaining power etc.

3. TEST MODE

A. SYSTEM MENU



IMPORTANT!

- When you have changed the settings of the SYSTEM ASSIGNMENTS, COIN ASSIGNMENTS, and GAME ASSIGNMENTS (on the GAME TEST MODE screen), be sure to select the EXIT from the SYSTEM MENU screen and press the test button to exit from a test mode. This action can store the new settings in the IC on the board. Disconnecting the power when in a test mode may fail to store the new settings and eventually the present settings may remain effective.
- This game allows you to set the number of players to 2 or 4. Correctly set it according to the number of the input cables connected to the cabinet. Failure to do so may malfunction the game.

This test mode mainly allows the IC Board to be checked for accurate functioning, monitor color to be adjusted as well as COIN ASSIGNMENTS and GAME ASSIGNMENTS to be adjusted.

1) After turning power on, press the TEST Button to have the following SYSTEM MENU displayed.

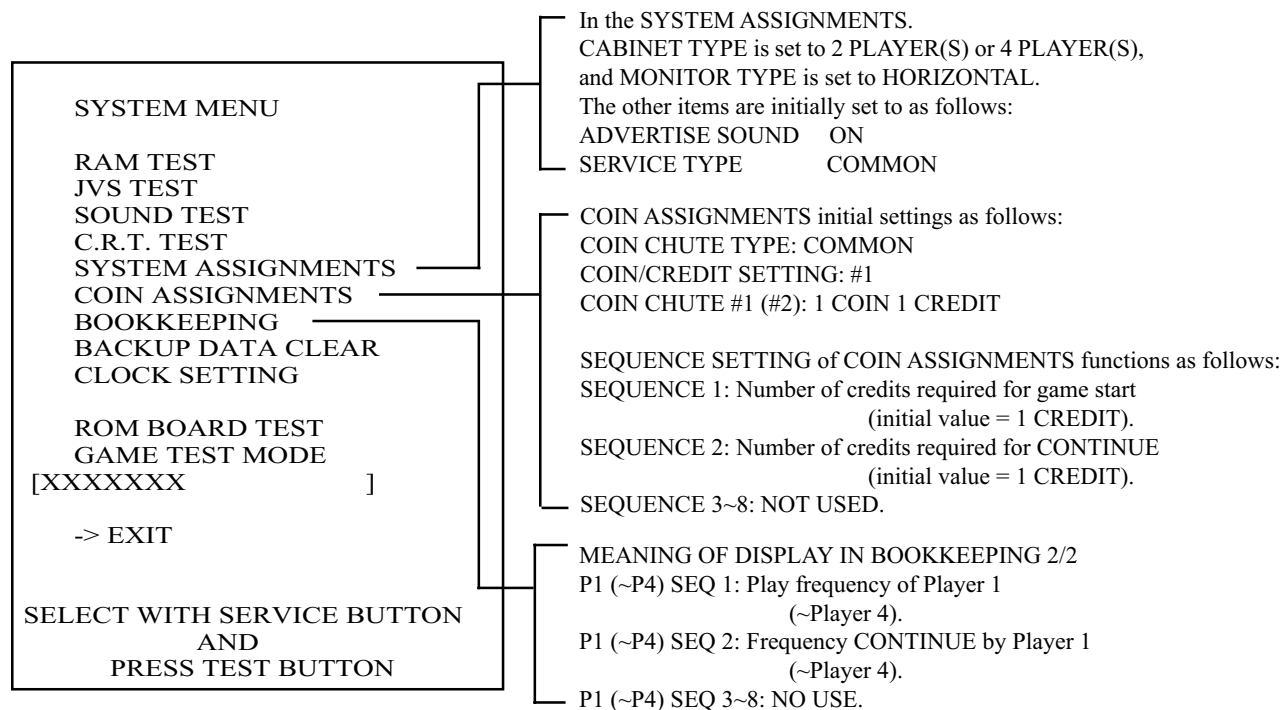

CAUTION FOR SETTING

When you have set the SERVICE TYPE and the COIN CHUTE TYPE to INDIVIDUAL, the players 1 and 2 share the credit of COIN 1 and SERVICE 1 while the players 3 and 4 share the credit of COIN 3 and SERVICE 3.

If you want to use the coin chute for COIN 2 (4) and the service button for SERVICE 2 (4), therefore, set the SERVICE TYPE and the COIN CHUTE TYPE to COMMON.

- 2) Press the SERVICE Button to move the arrow. Bring the arrow to the desired item and press the TEST Button.
- 3) Press the TEST Button in the GAME TEST MODE to display the GAME TEST MODE peculiar to this game. See the next page onward.
- 4) Upon finishing the test, bring the arrow to EXIT and press the TEST Button to return to the Game mode.

For detailed explanations as regards the SYSTEM TEST MODE, refer to NAOMI SERVICE MANUAL (420-6455-01).

B. GAME TEST MODE

Move the -> mark to GAME TEST MODE item on the SYSTEM MENU screen, and press the TEST Button. The game-specific GAME TEST MODE screen appears.

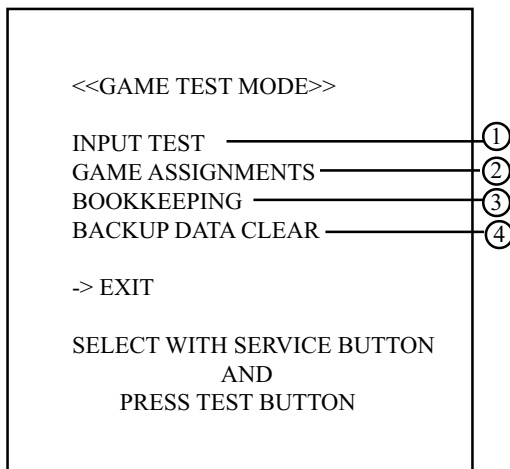

GAME TEST MODE screen

Pressing the SERVICE Button can move the -> mark. Move the -> mark to a desired item, and press the TEST Button.

After testing, select the EXIT and press the TEST Button. The SYSTEM MENU screen reappears.

① INPUT TEST

This screen tests the input devices.

```

<<INPUT TEST>>

TEST BUTTON      [OFF]
SERVICE BUTTON  [OFF]

                1P          2P
START            [OFF]      [OFF]
ATTACK           [OFF]      [OFF]
GRAPPLE          [OFF]      [OFF]
SUPPORT          [OFF]      [OFF]
STICK            [0][0][0]   [0][0][0]
                [0] [0]     [0] [0]
                [0][0][0]   [0][0][0]

PRESS SERVICE BUTTON
AND
TEST BUTTON TO EXIT
    
```

Press each button and make sure that the corresponding OFF disappears and the ON appears.

TEST Changes to ON when pressing the TEST BUTTON.

SERVICE Changes to ON when pressing the SERVICE BUTTON.

START Changes to ON when pressing the START BUTTON.

ATTACK Changes to ON when pressing the ATTACK BUTTON.

GRAPPLE Changes to ON when pressing the GRAPPLE BUTTON.

SUPPORT Changes to ON when pressing the SUPPORT BUTTON.

LEVER From 0 to 1 on the set direction.

0 0 0	If set to the upper	0 0 1
0 0	<u>right direction.</u>	0 0
0 0 0		0 0 0

If the CABINET TYPE is set to 4 PLAYER(S) on the SYSTEM ASSIGNMENTS screen, the 3P and 4P columns, are displayed.

② GAME ASSIGNMENTS

This screen sets the difficulty level and playing time. Press the SERVICE Button to move to a desired item, and press the TEST Button to select a new setting.

```

<< GAME ASSIGNMENTS >>

DIFFICULTY          [NORMAL]
TIME LIMIT          [180]
RESET

EXIT

SELECT WITH SERVICE BUTTON
AND
PRESS TEST BUTTON
    
```

DIFFICULTY 5 levels are selectable.

TIME LIMIT Playing time in minute for a game. 60, 120, or 180 is selectable.

RESET Initial settings are recovered.

Initial settings are:

DIFFICULTY NORMAL

TIME LIMIT 180

③ BOOKKEEPING

This screen displays the playing time data.

```
<< BOOKKEEPING >> PAGE 1/2

PLAY TIME           - D - H - M - S
AVERAGE TIME       - M - S
LONGEST TIME        - M - S
SHORTEST TIME       - M - S

PRESS TEST BUTTON TO CONTINUE
```

PLAY TIME Actual playing time data (For 2P game, playing time periods are not overlapped.)

Press the TEST Button to open the next PAGE 2/2 screen.

```
<< BOOKKEEPING >> PAGE 2/2

0M00S ~ 0M29S -
0M30S ~ 0M59S -
1M00S ~ 1M29S -
1M30S ~ 1M59S -
2M00S ~ 2M29S -
2M30S ~ 2M59S -
3M00S ~ 3M29S -
3M30S ~ 3M59S -
4M00S ~ 4M29S -
4M30S ~ 4M59S -
5M00S ~ 5M29S -
5M30S ~ 5M59S -
6M00S ~ 6M29S -
6M30S ~ 6M59S -
7M00S ~ 7M29S -
7M30S ~ 7M59S -
8M00S ~ 8M29S -
8M30S ~ 8M59S -
9M00S ~ 9M29S -
9M30S ~ 9M59S -
OVER 10M00S -

PRESS TEST BUTTON TO EXIT
```

This screen indicates the by-playtime play frequency.

Press the TEST Button to return to the GAME TEST MODE screen.

④ BACKUP DATA CLEAR

```
<< BACKUP DATA CLEAR >>

YES (CLEAR)
-> NO (CANCEL)

SELECT WITH SERVICE BUTTON
AND PRESS TEST BUTTON
```

This screen clears the high scores and the bookkeeping data.

Press the SERVICE Button to move the -> mark to YES item, and press the TEST Button. When the system completes clearing, the COMPLETED message appears on the screen. Press the TEST Button to return to the GAME TEST MODE screen. Press the SERVICE Button to move the -> mark to NO item, and press the TEST Button. The system does not execute clearing, but returns to the GAME TEST MODE screen.

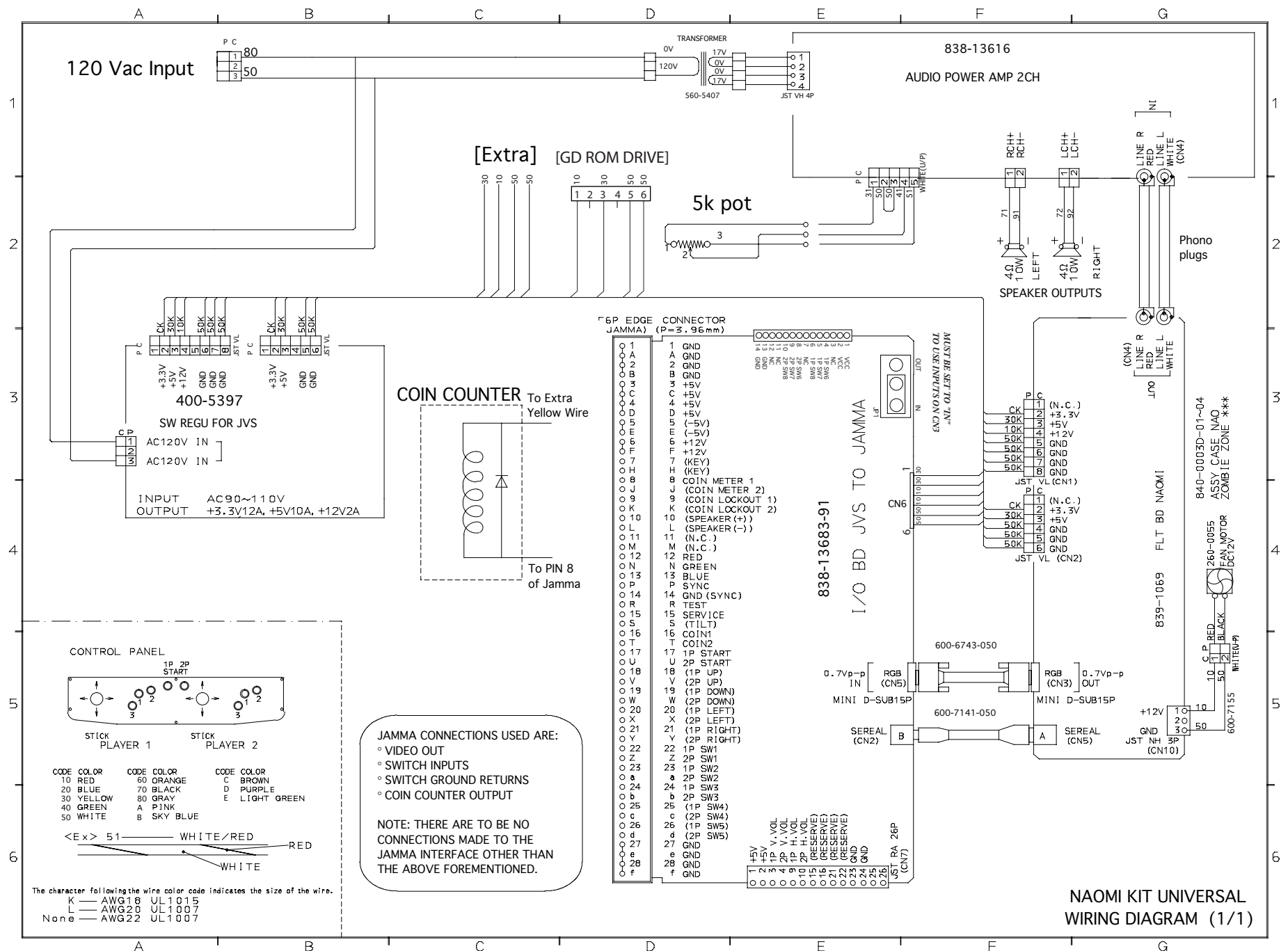

120 Vac Input



TRANSFORMER

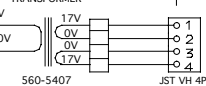

838-13616

AUDIO POWER AMP 2CH

[Extra] [GD ROM DRIVE]

5k pot

SPEAKER OUTPUTS

Phono plugs

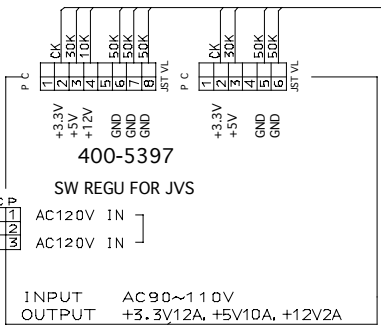

COIN COUNTER To Extra Yellow Wire

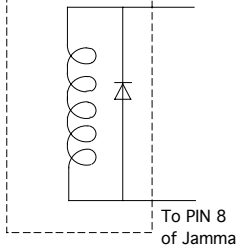

6P EDGE CONNECTOR (P=3.96mm)

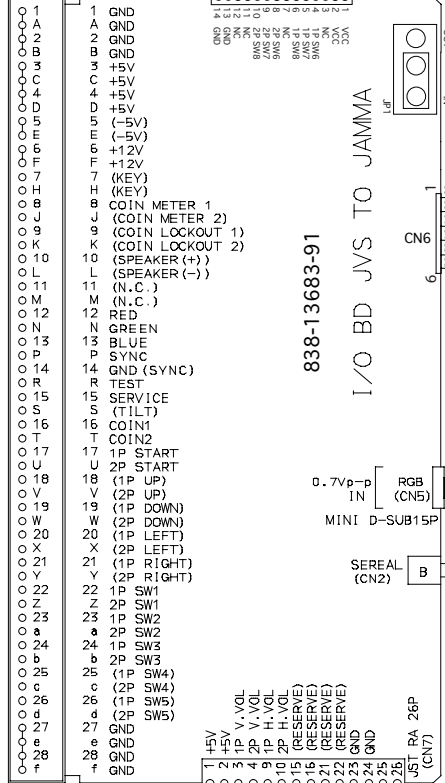

838-13663-91

I/O BD JVS TO JAMMA

CONTROL PANEL

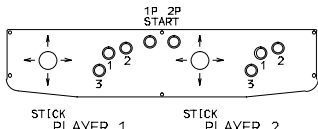

CODE	COLOR	CODE	COLOR	CODE	COLOR
10	RED	60	ORANGE	C	BROWN
20	BLUE	70	BLACK	D	PURPLE
30	YELLOW	80	GRAY	E	LIGHT GREEN
40	GREEN	A	PINK		
50	WHITE	B	SKY BLUE		

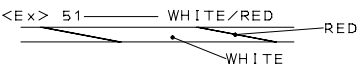

JAMMA CONNECTIONS USED ARE:
 • VIDEO OUT
 • SWITCH INPUTS
 • SWITCH GROUND RETURNS
 • COIN COUNTER OUTPUT

NOTE: THERE ARE TO BE NO CONNECTIONS MADE TO THE JAMMA INTERFACE OTHER THAN THE ABOVE FOREMENTIONED.

The character following the wire color code indicates the size of the wire.
 K — AWG18 UL1015
 L — AWG20 UL1007
 None — AWG22 UL1007

NAOMI KIT UNIVERSAL WIRING DIAGRAM (1/1)

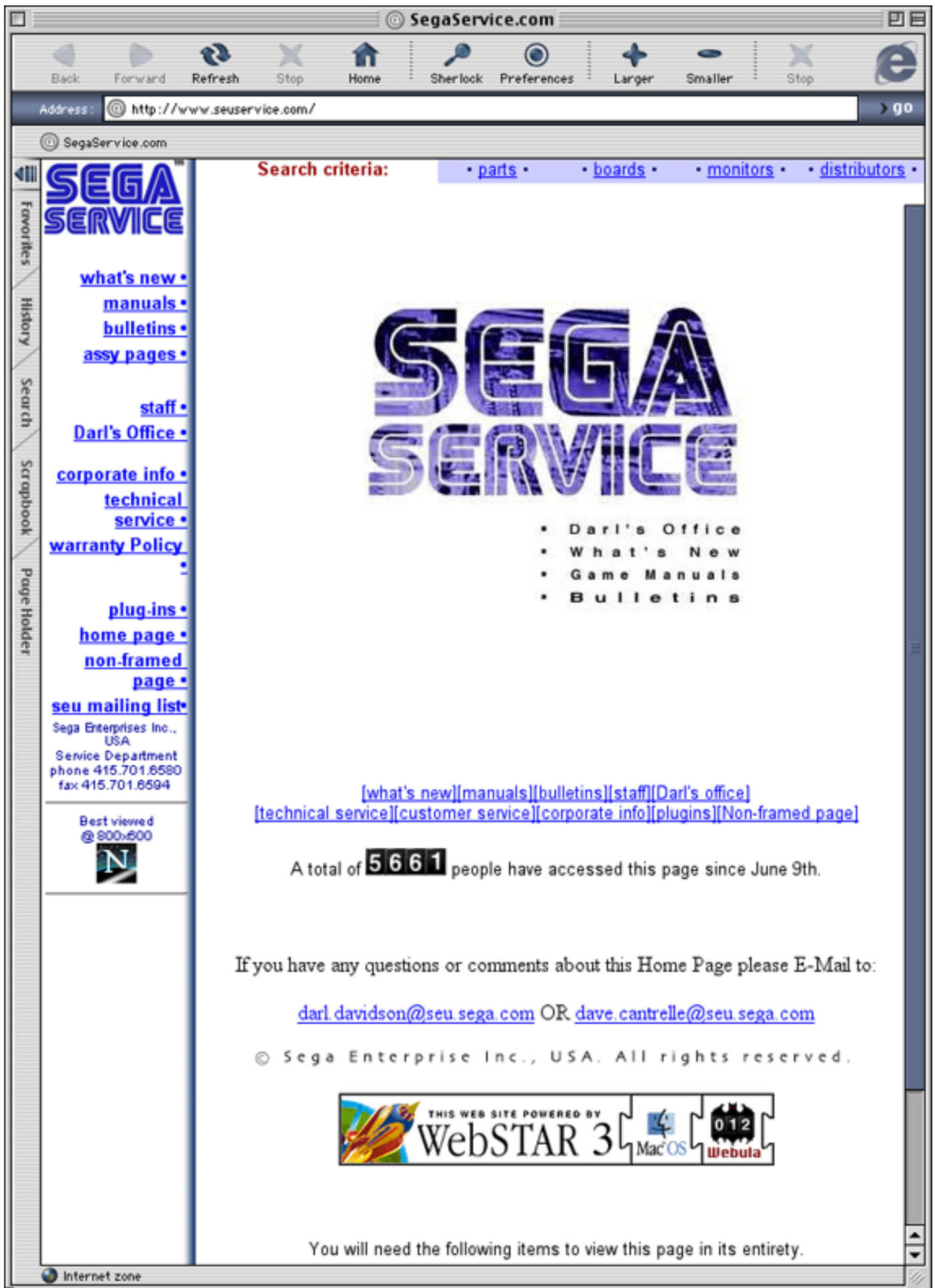

Search criteria:

- [parts](#) •
- [boards](#) •
- [monitors](#) •
- [distributors](#) •



- [what's new](#) •
- [manuals](#) •
- [bulletins](#) •
- [assy pages](#) •

- [staff](#) •
- [Darl's Office](#) •

- [corporate info](#) •
- [technical service](#) •
- [warranty Policy](#) •

- [plug-ins](#) •
- [home page](#) •
- [non-framed page](#) •

[seu mailing list](#)

Sega Enterprises Inc.,
USA
Service Department
phone 415.701.8590
fax 415.701.8594

Best viewed
@ 800x600



- Darl's Office
- What's New
- Game Manuals
- Bulletins

[\[what's new\]](#)[\[manuals\]](#)[\[bulletins\]](#)[\[staff\]](#)[\[Darl's office\]](#)
[\[technical service\]](#)[\[customer service\]](#)[\[corporate info\]](#)[\[plugins\]](#)[\[Non-framed page\]](#)

A total of **5661** people have accessed this page since June 9th.

If you have any questions or comments about this Home Page please E-Mail to:

darl.davidson@seu.sega.com OR dave.cantrelle@seu.sega.com

© Sega Enterprise Inc., USA. All rights reserved.



You will need the following items to view this page in its entirety.



SEGA ENTERPRISES, INC. (USA)

45133 Industrial Drive
Fremont, CA 94538
(415) 701-6580 phone
(415) 701-6594 fax